



Building Research Institute

**ITB TECHNICAL APPROVAL  
AT-15-9164/2013**

**BELLA PLAST Finishing profiles  
+ANNEX NO. 1**

WARSAW

The technical approval has been developed at the  
Department of Technical Approvals by Agnieszka  
FLESZAR, PhD, Eng.

Cover design: Ewa Kossakowska

Made from originals without preparation for publishing  
GW VIII

The technical approval may only be copied in full

© Copyright by Building Research Institute Warsaw  
2014

ISBN 978-83-249-7670-6

i)  
**Building Research Institute**

Knowledge Dissemination Department  
02-656 Warsaw, ul. Ksawerów 21, tel.: 22 843 35 19  
Pdf format published in September 2014 Order No. 586/2014



Series: TECHNICAL APPROVALS

## ITB TECHNICAL APPROVAL AT-15-9164/2013

On the basis of the Regulation of the Minister of Infrastructure of 8 November 2004 on technical approvals and organisational entities authorised to issue them (Journal of Laws, No. 249 of 2004, item 2497), following the approval procedure carried out in the Building Research Institute in Warsaw, at the request of:

**Bella Plast Sp. z o.o.**  
**ul. Długa 86, 05-075 Warszawa - Wesola**

we hereby confirm the suitability for use in construction of products under the name:

**BELLA PLAST Finishing profiles**

in the scope and on the terms set out in the Appendix, which forms an integral part of this ITB Technological Approval.

Expires:  
30.09.2018

DIRECTOR  
of the Building Research Institute  
[signature]  
Jan Bobrowicz

[round stamp]  
BUILDING RESEARCH INSTITUTE

Attachment:  
General and Technical Provisions

Warsaw, 25 September 2015

The ITB Technical Recommendations Document AT-15-9164/2013 contains 23 pages. The text of this document may be copied only in its entirety. Publication or dissemination in any other form of fragments of the Technical Approval text requires a written agreement with the Building Research Institute.

## GENERAL AND TECHNICAL PROVISIONS

### TABLE OF CONTENTS

1. SUBJECT OF THE APPROVAL.....	3
2. PURPOSE, SCOPE AND CONDITIONS OF USE .....	4
3. TECHNICAL PROPERTIES. REQUIREMENTS .....	5
4. PACKAGING, STORAGE AND TRANSPORT.....	6
5. ASSESSMENT OF COMPLIANCE.....	6
5.1. General principles.....	6
5.2. Initial type testing .....	7
5.3. Factory production control .....	7
5.4. Testing of finished products .....	8
5.5. Frequency of testing .....	8
5.6. Testing methods.....	8
5.7. Test specimens .....	9
5.8. Evaluation of test results.....	9
6. FORMAL AND LEGAL DECISIONS .....	9
7. EXPIRY DATE.....	10
ADDITIONAL INFORMATION.....	11
FIGURES.....	12

## 1. SUBJECT OF THE APPROVAL

This ITB Technical Approval is issued for BELLA PLAST PVC finishing profiles manufactured by Bella Plast Sp. z o.o., ul. Długa 86, 05-075 Warsaw - Wesola in the Production Plant of Bella Plast Sp. z o.o., ul. Szczęśliwa 51, 05-074 Długa Kościelna.

The profiles covered by the Approval are made of hard polyvinyl chloride (PVC).

The product range covered by the Approval includes:

- A) BELLA PLAST finishing profiles for BSO thermal insulation systems (ETICS):
- BP13 (6 mm / 9 mm), BP13 MINI (3 mm / 6 mm), BP13 MIDI (3 mm / 9 mm) (Figure 1) - reveal beads with fibreglass mesh,
  - BP14 LUX (Fig. 2) - driptop bead with fibreglass mesh,
  - BP14 ECO PLUS (Fig. 3) - driptop bead with fibreglass mesh,
  - BP11 H1, BP11 H2, BP11 H3, BP11 H3 N, BP11 H5 (Fig. 4) - groove beads,
  - BP10 (Fig. 5) - corner bead with fibreglass mesh,
  - BP11 H1S, BP11 H2S, BP11 H3S, BP11 H3 NS, BP11 H5S (Fig. 6) - groove beads with fibreglass mesh,
  - BP15 (Fig. 7) - movement bead with fibreglass mesh,
  - BP16 (Fig. 8) - movement bead,
  - BP20 (Fig. 9) - movement bead, under sill, with fibreglass mesh,
  - BP22 (Fig. 10) - bead with fibreglass mesh,
  - BP4 S (Fig. 11) - corner bead with fibreglass mesh,
  - BP11 Ł H1, BP11 Ł H2, BP11 Ł H3, BP11 Ł H5 (Fig.12) - connectors for groove beads,
  - BP11 K H3 WEW (Fig. 13) - inside corner bead, for groove beads: BP11H3, BP11H3S, BP11H3NS and BP11H3N,
  - BP11 K H3 ZEW (Fig. 14) - outside corner bead, for groove beads BP11H3, BP11H3S, BP11H3NS and BP11H3N,
  - BP11 MINI (Fig. 15) - groove bead with fibreglass mesh,
- B) BELLA PLAST finishing profiles for plasterboard:
- BP2 (Fig. 16) - straight corner bead for connecting and strengthening 90° plasterboard connections,
  - BP3 (Fig. 17) - arched corner bead for connecting and strengthening 90° plasterboard connections,
  - BP4 (Fig. 18) - universal corner bead for connecting and strengthening 0° - 180° plasterboard connections,

- BP5 (Fig. 19) - "J" finishing strip for reinforcing and aligning plasterboard edges,
- BP8 (Fig. 20) - bullnose corner bead for connecting and strengthening 90° plasterboard connections,
- BP9 (Fig. 21) - bullnose archway corner bead for connecting and strengthening 90° plasterboard connections,

C) BELLA PLAST protective and sealing finishing profiles for treatment from the inside:

- BP12 (6 mm / 9 mm), BP12MINI (3 mm / 6 mm), BP12 MIDI (3 mm/ 9 mm) (Fig. 22) - reveal beads,
- BP23 (Fig. 23) - bead with 4 mm ridge for reinforcing and making 90° corners beads.

Standard length of BELLA PLAST finishing profiles are 150, 200, 250 and 300 cm, the profiles can also be produced in lengths of 100 to 2500 cm upon request.

Required technical and functional properties of BELLA PLAST finishing profiles are specified in section 3.

## 2. PURPOSE, SCOPE AND CONDITIONS OF USE

BELLA PLAST finishing profiles are intended for:

- Strengthening and protecting the edges and corners of walls, finishing window and door openings and for making expansion joints in jointless insulation systems of external walls of buildings; products can be used indoors as well as outdoors - in the case profiles, according to section 1.A,
- Making and strengthening plasterboard connections; products can be used inside buildings - in the case profiles, according to section 1.B,
- For finishing window openings and strengthening corners, inside buildings - for profiles according to section 1.C.

Profile covered by the Approval can be covered with cement, lime or gypsum plaster.

Products covered by the Approval should be used in accordance with the detailed design developed for a particular building, taking into account:

- Regulation of the Minister of Infrastructure of 12 April 2002 on the technical conditions to be met by buildings and their location (Journal of Laws of 2002 No. 75, Item 690, as amended),
- The provisions of this Technical Approval,
- Instructions developed by the manufacturer.

## 3. TECHNICAL PROPERTIES. REQUIREMENTS

Required technical properties of BELLA PLAST finishing profiles are specified in table 1.

Table 1

Item	Properties	Requirements	Testing methods
1	2	3	4
1	External appearance and shape	Colour consistent with the manufacturer's colour chart; shape 1 + 23; lack of defects in the form of inclusions and discolouration; no mechanical damage	Section 5.6.1
2	Dimension, mm	Dimensions in accordance with Fig. 1 + 23, Tolerances in dimensional deviation for the coarse class C in accordance with PN-EN 22768-1:1999	Measurement using universal measuring tools, ensuring proper accuracy
3	Deviation from flat surface, mm, profiles with length of: - L < 2500 mm - L > 2500 mm	< 0.5 < 1.0	PN-EN 13658-1:2009
4	Vicat softening temperature, °C (in silicone oil)	> 70	PN-EN ISO 306:2006
5	Density of material, g/cm <sup>3</sup>	1.65 ± 10 %	PN-EN ISO 1183-1:2006
6	Charpy impact strength kJ/m <sup>2</sup>	> 20	PN-EN ISO 179-1:2010 (metoda 1fU)
7	Dimensional stability, as determined by the dimensional change after exposure to temperature of +70°C, %	< 0.1	Section 5.6.2
8*)	Adhesion, kPa, of glued reveal beads <sup>*)</sup> to the surfaces of: - Wood - Aluminium - PVC	> 90 > 200 > 70	Section 5.6.3
9*)	Resistance to mortars (cement, lime, gypsum), and adhesive mortars for polystyrene	No stains, pitting, loss of roughness and other visible damage to the profiles	Section 5.6.4
Property determined during the approval procedure, not covered by the initial type testing and testing of finished products Arrangement: bead - acrylic adhesive - surface			

#### 4. PACKAGING, STORAGE AND TRANSPORT

BELLA PLAST finishing profiles covered by the Approval should be delivered in original packaging of the manufacturer, protecting them from mechanical damage.

Each package must have a label containing at least the following data:

- Product name and its intended use,
- Manufacturer name and address,
- Dimensions,
- Number of ITB Technical Approval AT-15-9164/2013,
- Number and date of issuance of the national declaration of conformity,
- Construction product label.

The method of labelling products with the construction mark should be in accordance with the Regulation of the Minister of Infrastructure of 11 August 2004 on the methods of declaring the conformity of construction products and method of marking them with a construction product label (Journal of Laws No. 198, Item 2041, as amended).

BELLA PLAST finishing profiles should be stored in dry, ventilated spaces away from heating devices so as to ensure the safety of storage and invariability in technical properties of products. They can be transported by any means after securing the packaging against mechanical damage, in accordance with national transport regulations and the manufacturer's instructions.

#### 5. ASSESSMENT OF COMPLIANCE

##### 5.1. General principles

In accordance with Article 4, Article 5 Section 2, Section 3 and Article 8 Section 1 of the Act of 16 April 2004 on construction products (Journal of Laws No. 92/2004, item 881, as amended), the products covered by this Technical Approval may be marketed and used in construction works to the extent of their properties and purpose, if the manufacturer has conducted the assessment of conformity, issued a national declaration of conformity with the Technical Approval ITB AT-15-9164/2013 and labelled the products with the construction product label in accordance with applicable regulations.

In accordance with the Regulation of the Minister of Infrastructure of 11 August 2004 on the methods of declaring the conformity of construction products and method of marking them with a construction product label (Journal of Laws No. 198, Item 2041, as amended) of the assessment of conformity of the



BELLA PLAST finishing profiles with the Technical Approval ITB AT-15-9164/2013 is carried out by the manufacturer using the system 4.

In the case of system 4 of conformity assessment, the manufacturer may issue a national declaration of conformity with the Technical Approval ITB AT-15-9164/2013 on the basis of:

- a) Initial type-testing conducted by the manufacturer or on its behalf,
- b) Factory production control.

#### 5.2. Initial type testing

The ITT is a test confirming the required technical and operational properties, performed before placing the product on the market.

Initial type testing of BELLA PLAST finishing profiles includes:

- a) Vicat softening temperature,
- b) Density of material,
- c) Impact strength of material,
- d) Dimensional stability.

The tests, which in the approval procedure were used to determine the technical/performance properties of products constitute initial type testing in the assessment of compliance.

#### 5.3. Factory production control

Factory production control includes:

1. Specification and verification of raw materials and components,
2. Control and testing in the manufacturing process and testing of finished products (Section 5.4), conducted by the manufacturer in accordance with a prescribed test plan and in accordance with the rules and procedures set out in the documentation of factory production control, adapted to the production technology, and aiming to obtain products with desired properties.

Production control should ensure that the products comply with the Technical Approval ITB AT-15-9164/2013. Production control results should be systematically recorded. The records shall certify that products meet the criteria for conformity assessment. Individual products or batches of products and the related manufacturing details must be completely identifiable and repeatable.

#### 5.4. Testing of finished products

5.4.1. Program of testing. The program of testing includes:

- a) Current tests,
- b) Periodic tests.

5.4.2. Current tests. Current tests include checking:

- a) Appearance,
- b) Shape and dimensions.

5.4.3. Periodic tests. Periodic tests include checking:

- a) Vicat softening temperature,
- b) Density of material,
- c) Impact strength of material,
- d) Dimensional stability.

#### 5.5. Frequency of testing

Current tests should be carried out in accordance with a prescribed test plan, but not less frequently than every batch of products. The batch size should be specified in the documentation of factory production control.

Periodic testing should be performed at least once every three years.

#### 5.6. Testing methods

Test methods should be adopted in accordance with Table 1 and the following descriptions. The results should be compared respectively with the requirements given in Table 1.

5.6.1. Checking the appearance, Visual assessment must be carried out by visual inspection with the naked eye, in diffused light.

5.6.2. Checking dimensional stability. The dimensional stability of the dimensions of finishing strips after 24-hour impact of temperature of 70°C must be checked on 5 samples with dimensions (100 mm x nominal width x nominal thickness), assuming the nominal reference value of 100 mm. Sample after measuring distance in the indicated measuring points using callipers, should be placed for 24 hours in a climatic chamber at temperature of 70°C, and then conditioned for 2 hours under laboratory conditions,

Next, measure the length in the previous measuring point. Dimensional stability is defined by the change in linear dimensions in %.

5.6.3. Checking the adhesion of reveal beads to surfaces. Checking the adhesion of reveal beads to aluminium, wood and PVC surfaces after 24 hours should be performed on 6 samples with dimensions of (50 x 8 x 1) mm. Adhesion of beads to surfaces must be determined by testing of tensile strength perpendicular to the surface of the tested layer arrangement (arrangement: bead + acrylic adhesive + surface). The test must be carried out on a strength tester at a loading rate of 5 mm/min.

5.6.4. Checking resistance to mortars. Checking the resistance of profiles to mortar must be performed on 2 series of 3 samples for each type of mortar. The tested profiles with a length of 250 mm should be covered with limestone cement mortar, gypsum mortar and plaster adhesive for polystyrene. One series should be stored for 5 days in an air-conditioned room in a temperature of 23°C and relative humidity of 50%, while the second series 24 hours after bonding should be immersed in water to a depth of 0.5 cm (causing capillary rise) for 24 hours. Then, both series of samples should be observed with the naked eye, in order to evaluate the appearance of the profiles on the impact of the mortars used.

#### 5.7. Test specimens

Test specimens shall be taken at random in accordance with PN-83/N-03010.

#### 5.8. Evaluation of test results

Manufactured products can be considered as complying with the requirements of this ITB Technical Approval, if all tests results are positive.

## 6. FORMAL AND LEGAL DECISIONS

6.1. Technical Approval ITB AT-15-9164/2013 is a document certifying the suitability for use in construction of BELLA PLAST finishing profiles in the scope resulting from the Approval.

In accordance with Article 4, Article 5 Section 1.3 and Article 8 Section 1 of the Act of 16 April 2004 on construction products (Journal of Laws No. 92/2004, item 881, as amended), the products covered by this Technical Approval may be marketed and used in

construction works to the extent of their properties and purpose, if the manufacturer has conducted the assessment of conformity, issued a national declaration of conformity with the Technical Approval ITB AT-15-9164/2013 and labelled the products with the construction product label in accordance with applicable regulations.

6.2. The ITB Technical Approval is without prejudice to the rights resulting from the provisions on the protection of industrial property, in particular the notice of the Speaker of the Sejm of the Republic of Poland of 13 June 2003 on the publication of the consolidated text of the Act of June 30, 2000 - Industrial Property Law (Journal of Laws, No. 119, item 1117). Ensuring these rights is the responsibility of the beneficiaries of this ITB Technical Approval.

6.3. The ITB, by issuing the Technical Approval, is not responsible for any infringement of exclusive or acquired rights.

6.4. The ITB Technical Approval does not relieve the manufacturer from responsibility for proper quality of products, and building contractors from liability for their proper use.

6.5. The content published prospectuses and advertisements, and other documents related to the marketing and use of BELLA PLAST finishing profiles in construction should include information about the Technical Approval ITB AT-15-9164/2013 provided for the products.

## 7. EXPIRY DATE

The Technical Approval ITB AT-15-9164/2013 is valid until 30 September 2018.

ITB Technical Approval's validity may be extended for further periods, if the Applicant or its legal successor makes a formal request to the Building Research Institute no later than three months before the expiry date of this document.

THE END

## ADDITIONAL INFORMATION

## Standards and related documents

PN-83/N-03010 *Statistical quality control. Random selection of product units for sampling.*

PN-EN 22768-1:1999 *General tolerances. Tolerances of linear and angular dimensions without individual tolerance indications*

PN-EN 13658-1:2009 *Metal meshes, corner beads and concealed beads. Definitions, requirements and test methods. Part 1. Exterior plaster*

PN-EN ISO 306:2006 *Plastics. Thermoplastics. Determination of Vicat softening point (VST)*

PN-EN ISO 1183-1:2013 *Plastics. Methods for determining the density of non-porous plastics. Part 1: Immersion method, liquid pycnometer method and titration method*

PN-EN ISO 179-1:2010 *Plastics. Determination of Charpy impact strength. Part 1: Non-instrumental impact test*

Reports, test reports, classification and assessments

1. 1134/13/Z00NK. Research and technical opinion relating to the BELLA PLAST finishing profiles, Department of Construction and Building Elements Building Research Institute, Warsaw, 2013
2. LK00-1134/13/Z00NK. Test report for BELLA PLAST finishing profiles, Department of Construction and Building Elements Building Research Institute, Warsaw, 2013

FIGURES

Fig. 1.	Beads BP13, BP13 MINI, BP13 MIDI .....	13
Fig. 2.	Bead BP14 LUX .....	14
Fig. 3.	Bead BP14 ECO PLUS .....	14
Fig. 4.	Beads BP11 H1, BP11 H2, BP11 H3, BP11 H3N, BP11 H5 .....	15
Fig. 5.	Corner bead BP10 .....	15
Fig. 6.	Beads BP11 H1S, BP11 H2S, BP11 H3S, BP11 H3 NS, BP11 H5S .....	16
Fig. 7.	Bead BP15 .....	17
Fig. 8.	Bead BP16 .....	18
Fig. 9.	Bead BP20 .....	18
Fig. 10.	Bead BP22 .....	18
Fig. 11.	Corner bead BP 4S .....	19
Fig. 12.	Connectors BP11 Ł H1, BP11 Ł H2, BP11 Ł H3, BP11 Ł H5 .....	19
Fig. 13.	Corner bead BP11 K H3 WEW .....	20
Fig. 14.	Corner bead BP11 K H3 ZEW .....	20
Fig. 15.	Bead BP11 MINI .....	20
Fig. 16.	Corner bead BP2 .....	21
Fig. 17.	Corner bead BP3 .....	21
Fig. 18.	Corner bead BP4 .....	21
Fig. 19.	Bead BP5 .....	21
Fig. 20.	Corner bead BP8 .....	22
Fig. 21.	Corner bead BP9 .....	22
Fig. 22.	Beads BP12, BP12 MIDI, BP12 MINI .....	22
Fig. 23.	Bead BP23 .....	23

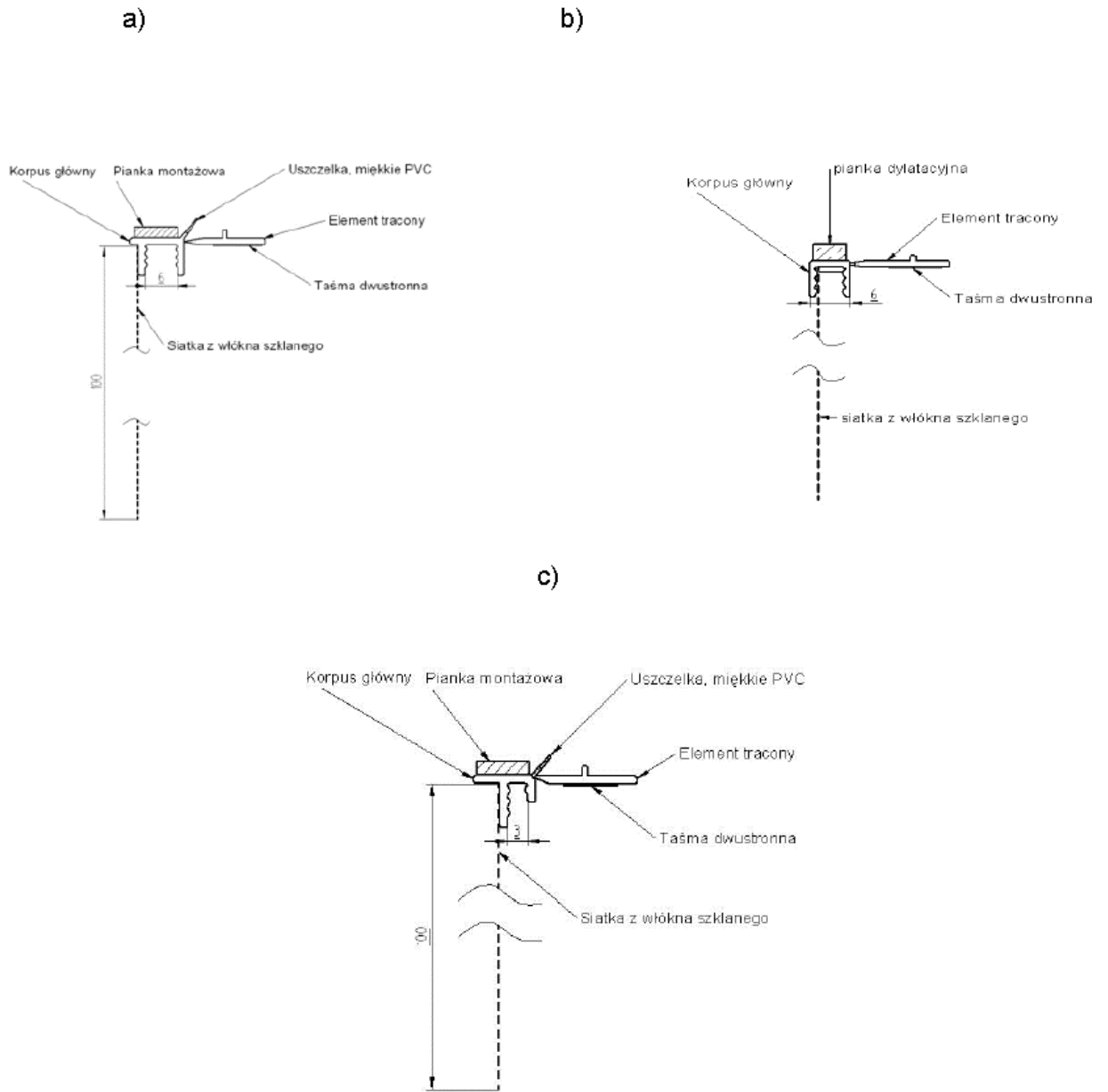

Fig. 1. Beads BP13 (a), BP13 MINI (b), BP13 MIDI (c)

Korpus główny	Main body
Pianka montażowa	Caulking foam
Uszczelka, miękkie PVC	Seal, soft PVC
Element tracony	Lost element
Taśma dwustronna	Double-sided tape
Siatka z włókna szklanego	Fibreglass mesh

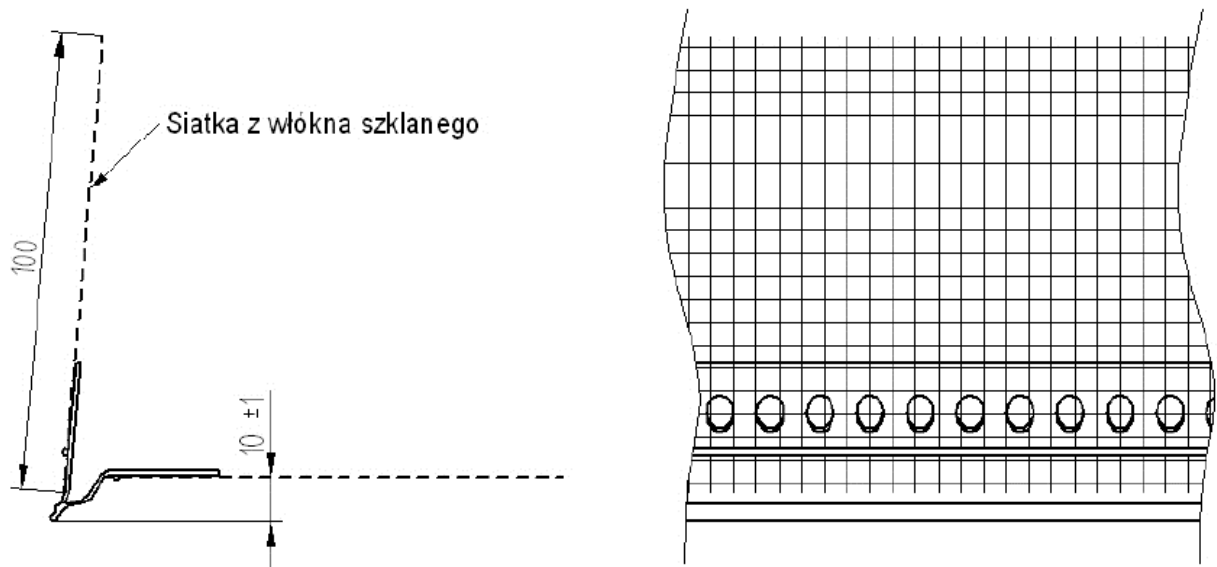

Fig. 2. Bead BP14 LUX

Siatka z włókna szklanego	Fibreglass mesh
---------------------------	-----------------

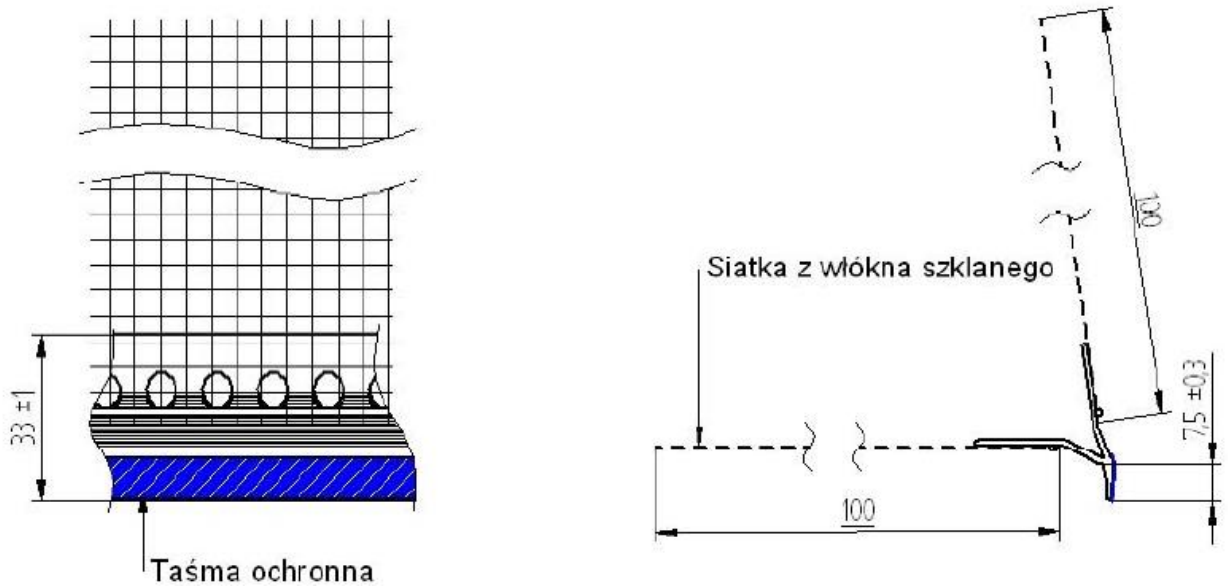

Fig. 3. Bead BP14 ECO PLUS

Siatka z włókna szklanego	Fibreglass mesh
Taśma ochronna	Protective tape



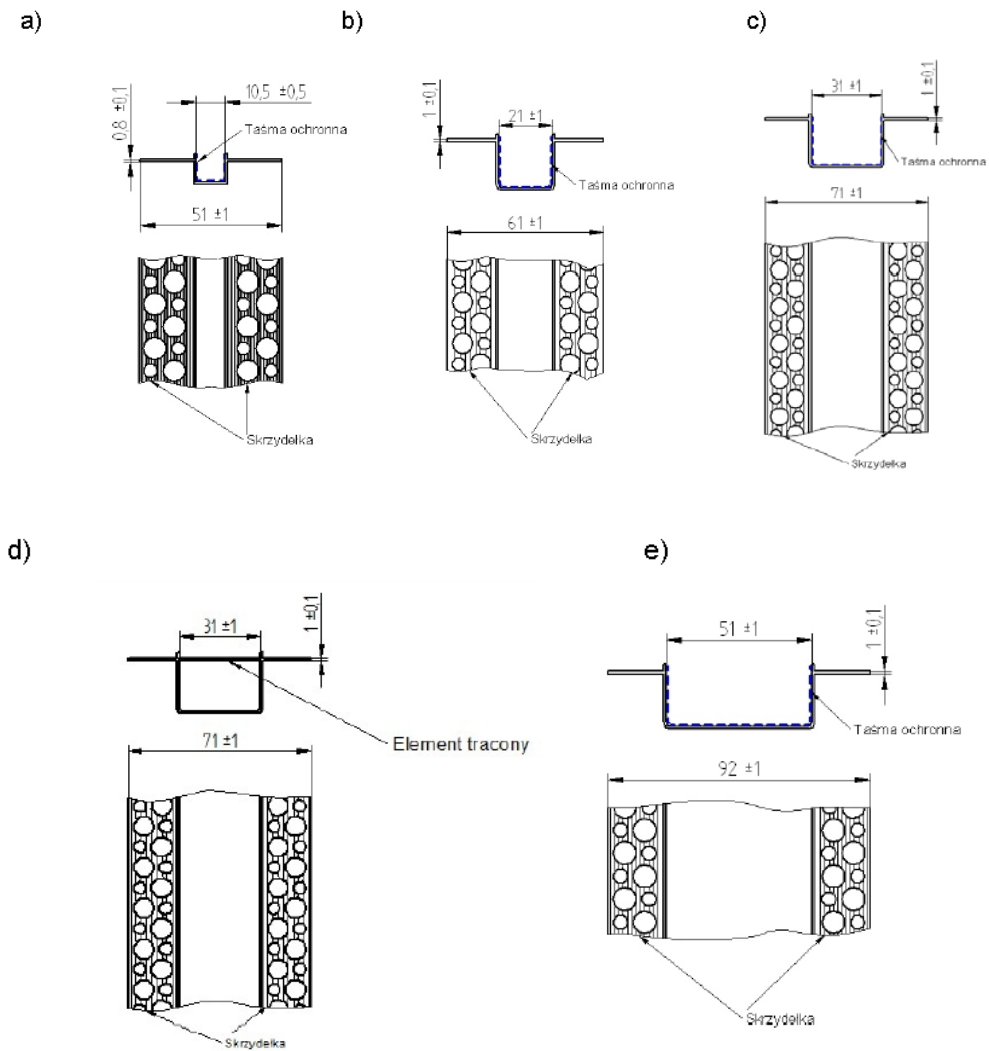

Fig. 4. Beads BP11 H1(a), BP11 H2 (b), BP11 H3 (c), BP11 H3N (d), BP11 H5 (e)

Siatka z włókna szklanego	Fibreglass mesh
Skrzydółka	Flaps
Element tracony	Lost element
Taśma ochronna	Protective tape

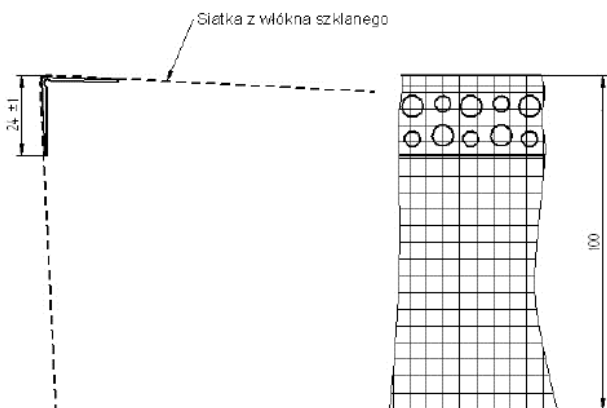
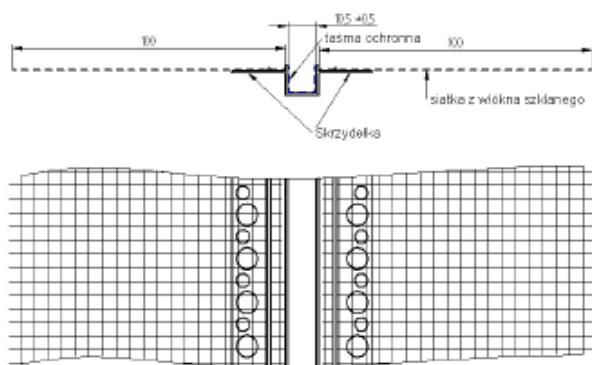
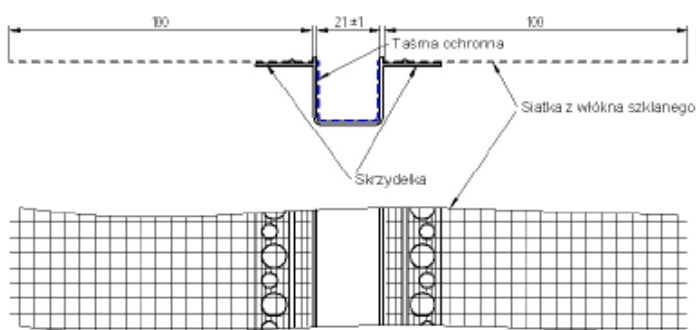

Fig. 5. Corner bead BP10

a)



b)



c)

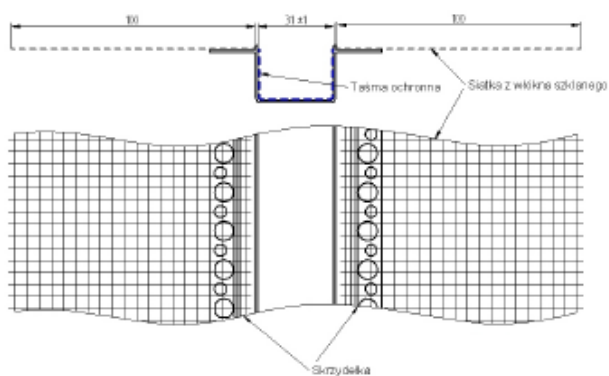
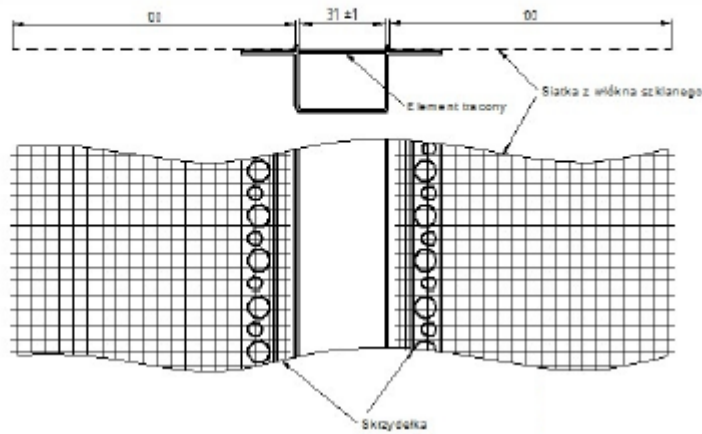

Fig. 6. Beads BP11 H1S (a), BP11 H2S (b), BP11 H3S (c), BP11 H3 NS (d), BP11 H5S (e)

Siatka z włókna szklanego	Fibreglass mesh
Skrzydółka	Flaps
Element tracony	Lost element
Taśma ochronna	Protective tape

d)

d)



e)

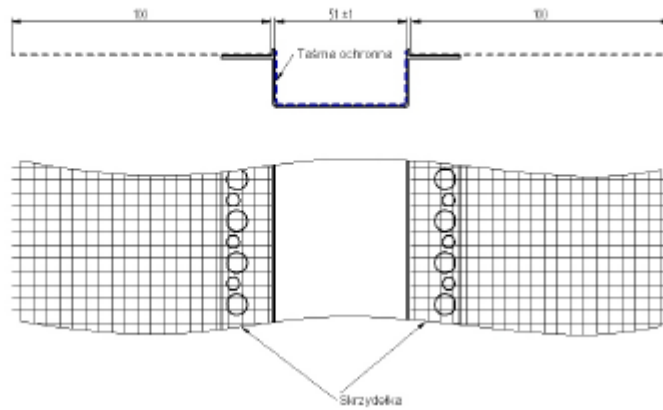

Fig. 6. Beads BP11 H1S (a), BP11 H2S (b), BP11 H3S (c), BP11 H3 NS (d), BP11 H5S (e) cont.

Siatka z włókna szklanego	Fiberglass mesh
Skrzydółka	Flaps
Element tracony	Lost element
Taśma ochronna	Protective tape
Elastyczny przegub	Flexible joint

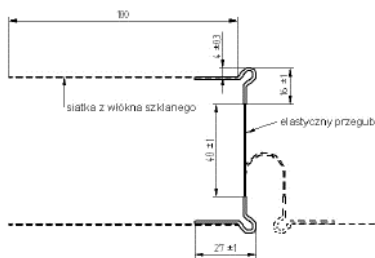

Fig. 7. Bead BP15

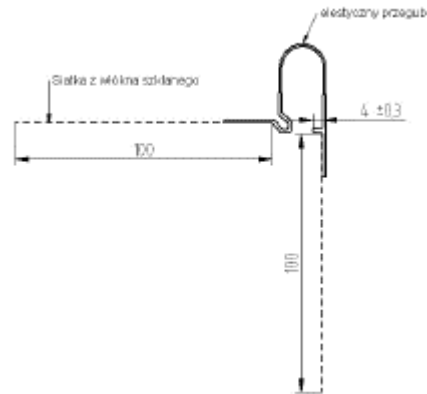

Fig. 8. Bead BP15

Siatka z włókna szklanego	Fibreglass mesh
Elastyczny przegub	Flexible joint
Pianka dylatacyjna, samoprzylepna	

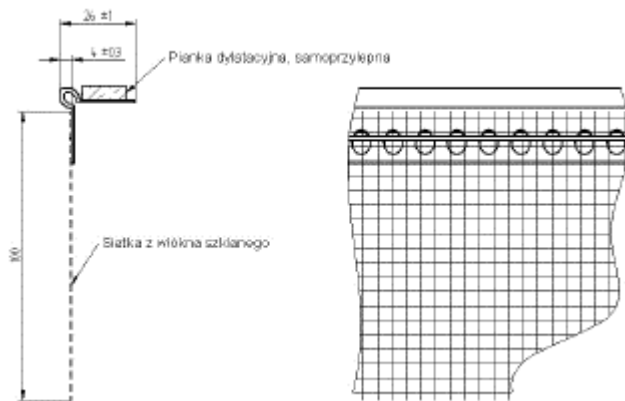

Fig. 9. Bead BP20

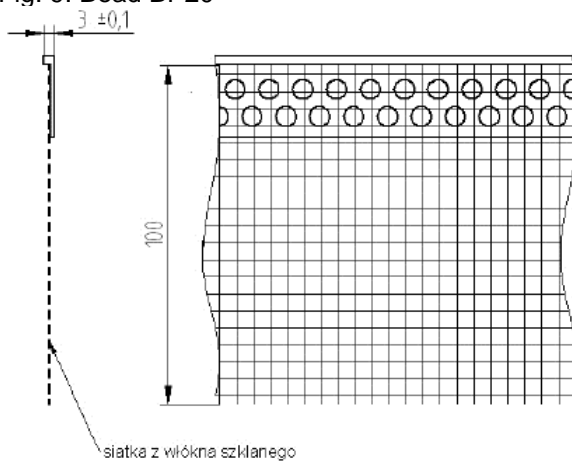

Fig. 10. Bead BP22

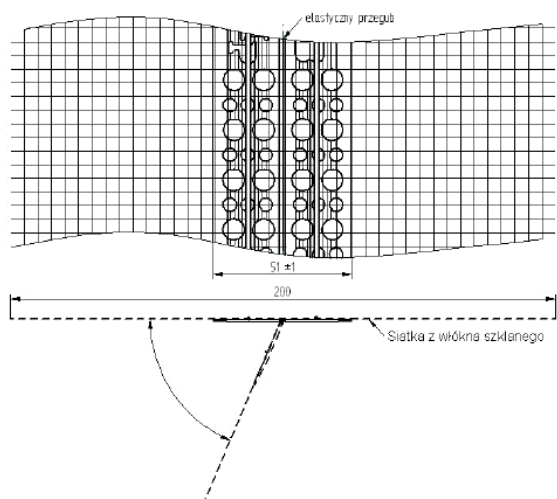
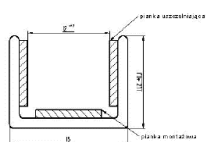

Fig. 11. Corner bead BP 4S

a)



b)

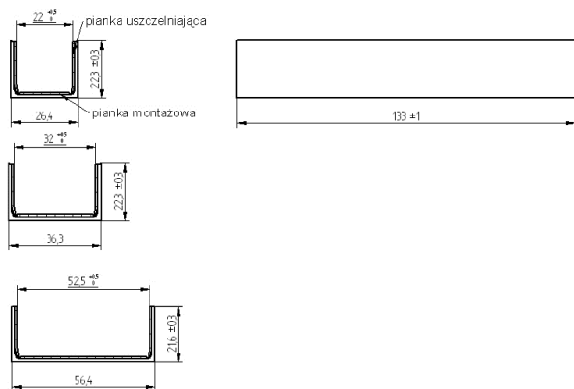

Fig. 12. Connectors BP11 Ł H1 (a) and BP11 Ł H2, BP11 Ł H3, BP11 Ł H5 (b)

Siatka z włókna szklanego	Fibreglass mesh
Elastyczny przegub	Flexible joint
Pianka montażowa	Caulking foam
Pianka uszczelniająca	Sealing foam

AT-15-9164/2013

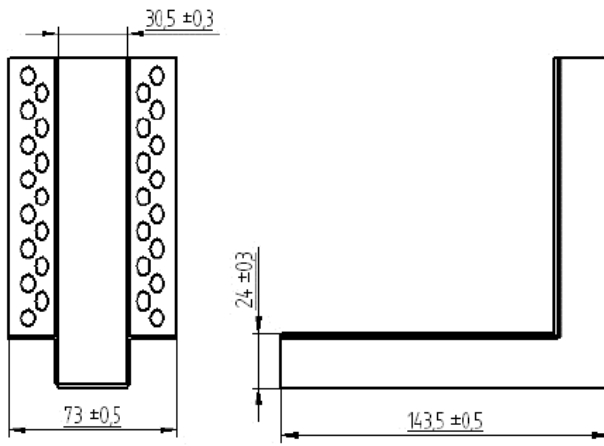

Fig. 13. Corner bead BP11 K H3 WEW

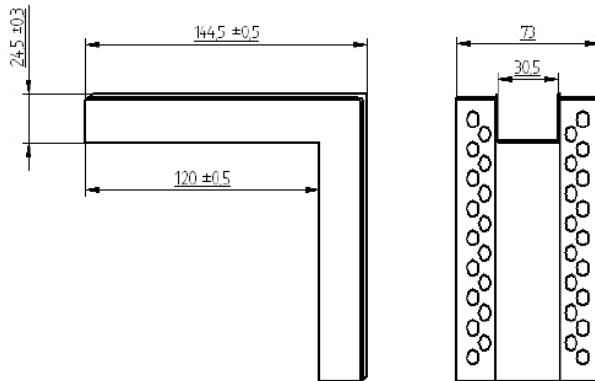
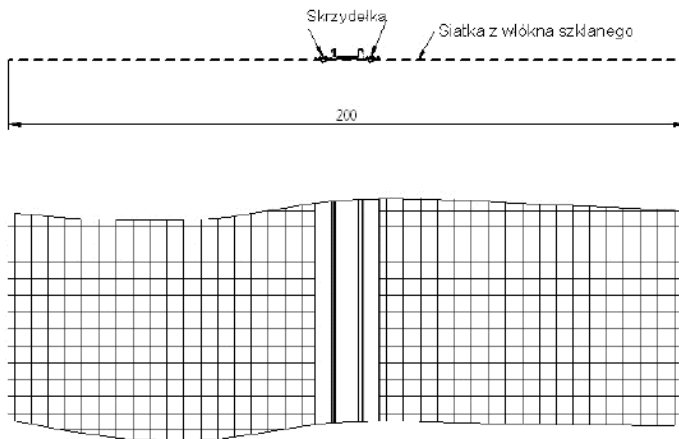

Fig. 14. Corner bead BP11 K H3 ZEW



Siatka z włókna szklanego	Fiberglass mesh
Skrzydółka	Flaps

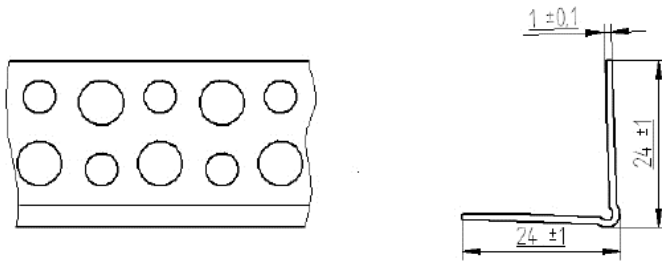

Fig. 16. Corner bead BP2

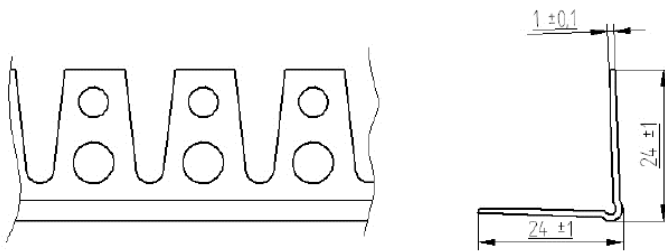

Fig. 17. Corner bead BP3

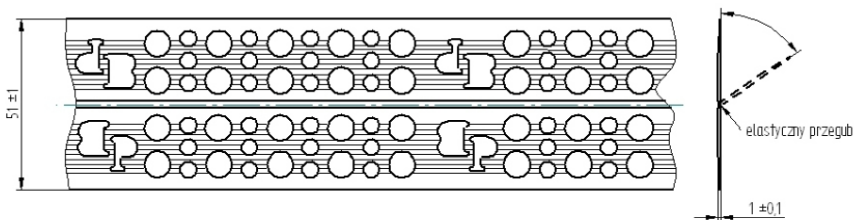

Fig. 18. Corner bead BP4

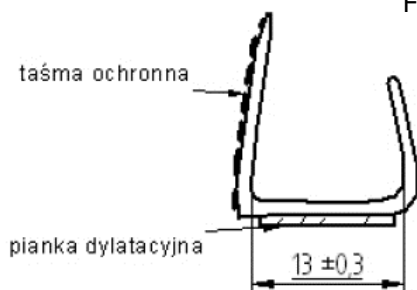

Fig. 19. Bead BP5

Siatka z włókna szklanego	Fibreglass mesh
Elastyczny przegub	Flexible joint
Pianka dylatacyjna	Expansion foam
Taśma ochronna	Protective tape

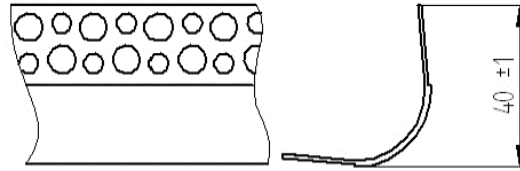

Fig. 20. Corner bead BP8

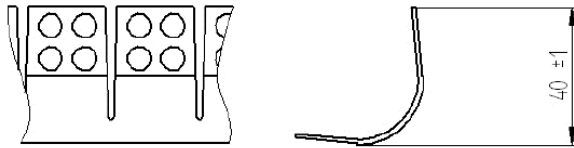
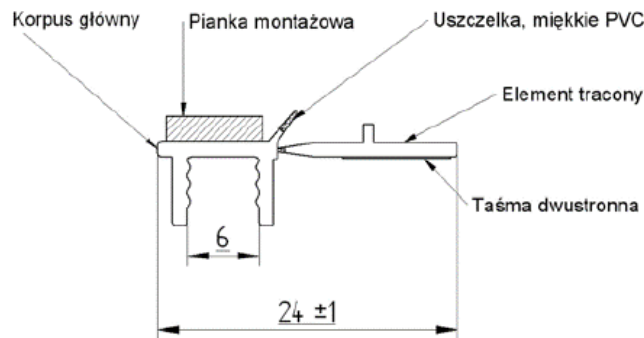

Fig. 21. Corner bead BP9

a)



b)

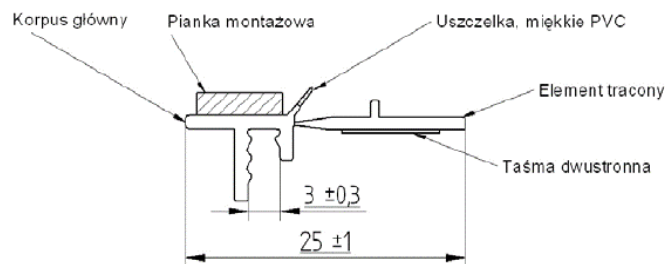

Fig. 22. Beads BP12 (a), BP12 MIDI (b), BP12 MINI (c)

Korpus główny	Main body
Pianka montażowa	Caulking foam
Uszczelka, miękkie PVC	Seal, soft PVC
Element tracony	Lost element
Taśma dwustronna	Double-sided tape
Siatka z włókna szklanego	Fibreglass mesh



c)

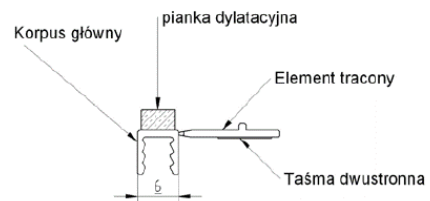

Fig. 22. Beads BP12 (a), BP12 MIDI (b), BP12 MINI (c), cont.

Korpus główny	Main body
Pianka dylatacyjna	Expansion foam
Element tracony	Lost element
Taśma dwustronna	Double-sided tape

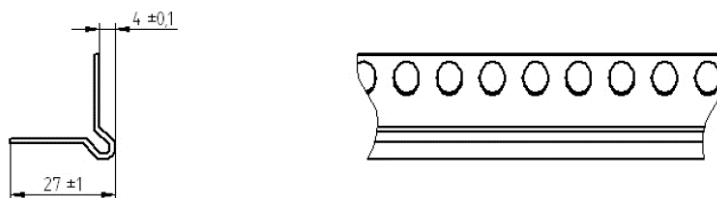

Fig. 23. Bead BP23



## **ANNEX NO. 1 TO THE ITB TECHNICAL APPROVAL AT-15-9164/2013**

On the basis of Regulation of the Minister of Infrastructure of 8 November 2004 on technical approvals and organisational entities authorised to issue them (Journal of Laws No. 249 of 2004, Item 2497), at the request of:

**Bella Plast Sp. z o.o.**  
**ul. Długa 86, 05-075 Warszawa - Wesola**

Technical Approval ITB AT-15-9164/2013, declaring suitability for use in construction of products under the

name:

**BELLA PLAST Finishing profiles**

is hereby amended as specified on pages 2 + 4 of the Annex.

DIRECTOR  
of the Building Research Institute  
[signature]  
Jan Bobrowicz

[round stamp]  
BUILDING RESEARCH INSTITUTE

Warsaw, 13 May 2014

Annex No. 1 to the ITB Technical Approval AT-15-9164/2013 contains 4 pages.

1. In section 1 of the Approval, the paragraph:

"The product range covered by the Approval includes:

A) BELLA PLAST finishing profiles for BSO thermal insulation systems (ETICS):

- BP13 (6 mm / 9 mm), BP13 MINI (3 mm / 6 mm), BP13 MIDI (3 mm / 9 mm) (Figure 1) - reveal beads with fibreglass mesh,
- BP14 LUX (Fig. 2) - driptop bead with fibreglass mesh,
- BP14 ECO PLUS (Fig. 3) - driptop bead with fibreglass mesh,
- BP11 H1, BP11 H2, BP11 H3, BP11 H3 N, BP11 H5 (Fig. 4) - groove beads,
- BP10 (Fig. 5) - corner bead with fibreglass mesh,
- BP11 H1S, BP11 H2S, BP11 H3S, BP11 H3 NS, BP11 H5S (Fig. 6) - groove beads with fibreglass mesh,
- BP15 (Fig. 7) - movement bead with fibreglass mesh,
- BP16 (Fig. 8) - movement bead,
- BP20 (Fig. 9) - movement bead, under sill, with fibreglass mesh,
- BP22 (Fig. 10) - bead with fibreglass mesh,
- BP4 S (Fig. 11) - corner bead with fibreglass mesh,
- BP11 L H1, BP11 L H2, BP11 L H3, BP11 L H5 (Fig. 12) - connectors for groove beads,
- BP11 K H3 WEW (Fig. 13) - inside corner bead, for groove beads: BP11H3, BP11H3S, BP11H3NS and BP11H3N,
- BP11 K H3 ZEW (Fig. 14) - outside corner bead, for groove beads BP11H3, BP11H3S, BP11H3NS and BP11H3N,
- BP11 MINI (Fig. 15) - groove bead with fibreglass mesh,"

is replaced with the following paragraph:

"The product range covered by the Approval includes:

A) BELLA PLAST finishing profiles for BSO thermal insulation systems (ETICS):

- BP13 (6 mm / 9 mm), BP13 MINI (3 mm / 6 mm), BP13 MIDI (3 mm / 9 mm) (Figure 1) - reveal beads with fibreglass mesh,
- BP14 LUX (Fig. 2) - driptop bead with fibreglass mesh,
- BP14 ECO PLUS (Fig. 3) - driptop bead with fibreglass mesh,
- BP11 H1, BP11 H2, BP11 H3, BP11 H3 N, BP11 H5, BP11 H2 R, BP11 H3 R, BP 11 H5 R (Fig. 4) - groove beads,
- BP10 (Fig. 5) - corner bead with fibreglass mesh,
- BP11 H1S, BP11 H2S, BP11 H3S, BP11 H3 NS, BP11 H5S, BP11 H2 RS, BP11 H3 RS, BP11 H5 RS (Fig. 6) - groove beads with fibreglass mesh,

Annex No. 1 to AT-15-9164/2013 3/4

- BP15 (Fig. 7) - movement bead with fibreglass mesh,
- BP16 (Fig. 8) - movement bead,
- BP20 (Fig. 9) - movement bead, under sill, with fibreglass mesh,
- BP22 (Fig. 10) - bead with fibreglass mesh,
- BP4 S (Fig. 11) - corner bead with fibreglass mesh,
- BP11 Ł H1, BP11 Ł H2, BP11 Ł H3, BP11 Ł H5 (Fig. 12) - connectors for groove beads,
- BP11 K H3 WEW (Fig. 13) - inside corner bead, for groove beads: BP11H3, BP11H3S, BP11H3NS and BP11H3N,
- BP11 K H3 ZEW (Fig. 14) - outside corner bead, for groove beads BP11H3, BP11H3S, BP11H3NS and BP11H3N,
- BP11 MINI (Fig. 15) - groove bead with fibreglass mesh"

2. FIGURES are supplemented with figures 4f), 4g) and 4h) and 6f), 6g) and 6 h):

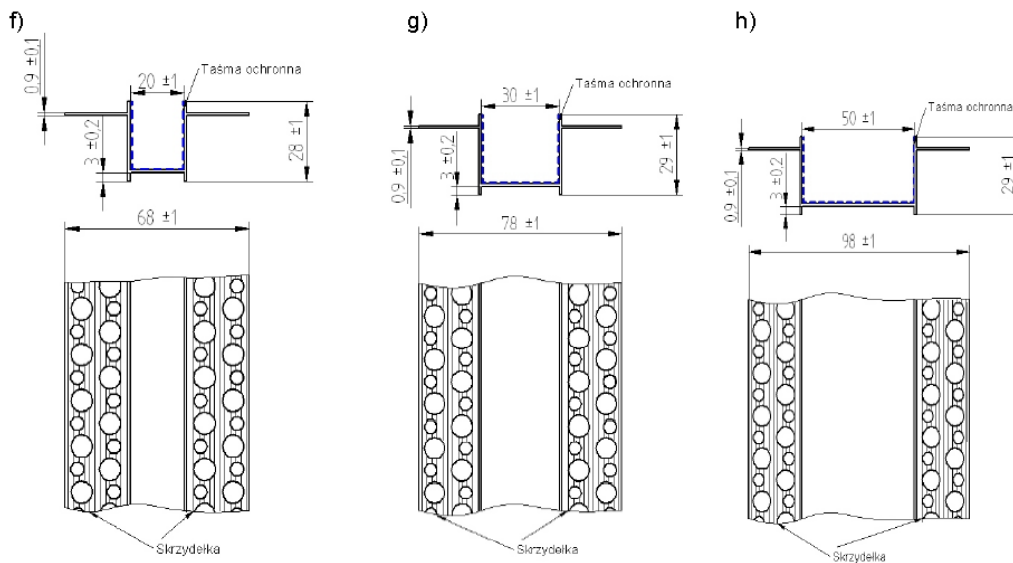

Fig. 4. Beads BP11 H1(a), BP11 H2 (b), BP11 H3 (c), BP11 H3N (d), BP11 H5 (e), BP11 H2 R (f), BP11 H3 R (g), BP11 H5 R (h)

Taśma ochronna	Protective tape
Skrzydółka	Flaps

f)

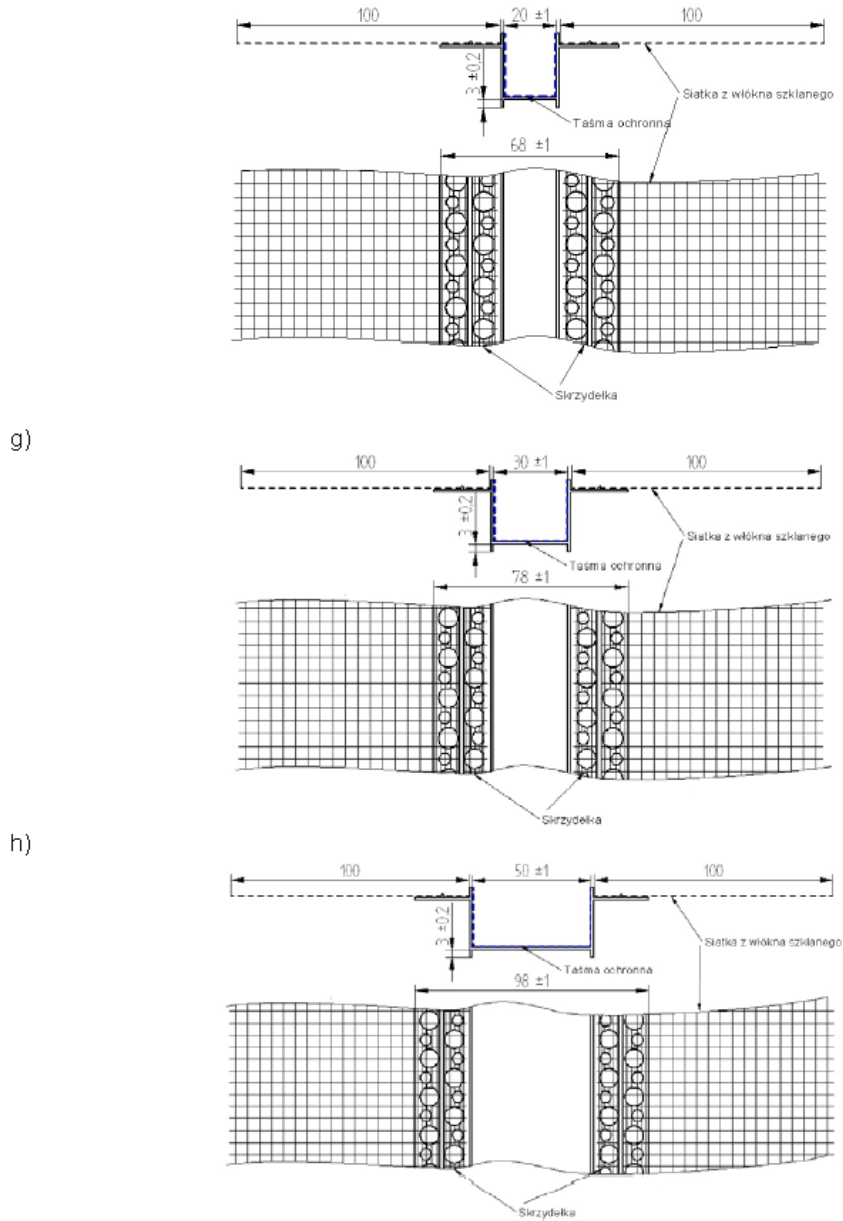

Fig. 6. Beads BP11 H1S (a), BP11 H2S (b), BP11 H3S (c), BP11 H3 NS (d), BP11 H5S (e), BP11 H2 RS (f), BP11 H3 RS (g), BP11 H5 RS (h)

Taśma ochronna	Protective tape
Skrzydółka	Flaps
Siatka z włókna szklanego	Fibreglass mesh

**THE END**



Building Research Institute

ISBN 978-83-249-7670-6